



AGV-SPO High-Performance Single Pivot-Point Laser Scan Head

HARDWARE MANUAL

Revision 2.02



GLOBAL TECHNICAL SUPPORT

Go to the [Global Technical Support Portal](#) for information and support about your Aerotech, Inc. products. The website supplies software, product manuals, Help files, training schedules, and PC-to-PC remote technical support. If necessary, you can complete Product Return (RMA) forms and get information about repairs and spare or replacement parts. To get help immediately, contact a service office or your sales representative. Include your customer order number in your email or have it available before you call.

This manual contains proprietary information and may not be reproduced, disclosed, or used in whole or in part without the express written permission of Aerotech, Inc. Product names mentioned herein are used for identification purposes only and may be trademarks of their respective companies.

Copyright © 2019-2025, Aerotech, Inc. | All rights reserved.

See the latest version of Aerotech's [Terms of Use](#), [Privacy Policy](#), and [Cookie Policy](#) online at aerotech.com.



Table of Contents

AGV-SPO High-Performance Single Pivot-Point Laser Scan Head	1
Table of Contents	3
List of Figures	4
List of Tables	5
EU Declaration of Incorporation	6
UKCA Declaration of Incorporation	7
Safety Procedures and Warnings	9
Installation and Operation	10
Laser Safety	11
Electrical Warnings	14
Motor-Related Warnings	15
Pinch Points	16
Handling and Storage	17
Chapter 1: Overview	19
1.1. Environmental Specifications	22
1.2. Accuracy and Temperature Effects	22
1.2.1. Power-On Thermal Drift	22
1.3. Basic Specifications	23
1.4. Vacuum Operation	24
Chapter 2: Mechanical Specifications and Installation	25
2.1. Scanner Dimensions	26
2.2. Optical Dimensions	27
2.3. Securing the Scan Head to the Mounting Surface	28
2.4. Attaching the Focal Lens to the Scan Head	30
2.5. Air Requirements	32
2.6. Water Requirements	33
Chapter 3: Electrical Specifications and Installation	35
3.1. Motor Connectors	36
3.2. Motor, Feedback, and Limit Specifications	38
3.3. Machine Direction	39
3.4. Feedback Phasing	40
Chapter 4: Maintenance	41
4.1. Service and Inspection Schedule	41
4.2. Cleaning and Lubrication	41
4.2.1. Focal Lens and Protective Glass	42
4.2.2. Turning Mirrors	43
4.3. Troubleshooting	44
Appendix A: Warranty and Field Service	45
Appendix B: Revision History	47
Index	49

List of Figures

Figure 1-1: Single Point Scanner Component Diagram	19
Figure 1-2: Standard AGV-SPO	20
Figure 2-1: AGV14SPO Galvanometer Scanner Dimensions	26
Figure 2-2: AGV-SPO Optical Dimensions	27
Figure 2-3: Example of F-Theta Lens (Complete Assembly)	30
Figure 2-4: Assembly of Focal Lens to Scan Head	31
Figure 2-5: Air-Cooling (-AC) Locations	32
Figure 2-6: Water Cooling (-WC) Locations	34
Figure 3-1: Galvo X-Axis Machine Direction (front)	39
Figure 3-2: Galvo Y-Axis Machine Direction (side)	39
Figure 3-3: Analog Encoder Phasing Reference Diagram	40

List of Tables

Table 1-1: Ordering Options	21
Table 1-2: Environmental Specifications	22
Table 1-3: AGV-SPO Series Specifications	23
Table 1-4: Mirror Specifications	23
Table 2-1: -AC Cooling Option Specifications	32
Table 2-2: -WC Cooling Option Specifications	33
Table 3-1: Aerotech Standard Scan Head to Controller Cable Part Numbers	36
Table 3-2: Scan Head Motor Connector Pinout	37
Table 3-3: Mating Connector Part Numbers for the Scan Head Motor Connector	37
Table 3-4: Scan Head Motor and Feedback Specifications	38
Table 3-5: Thermistor Specifications	38
Table 3-6: Limit Switch Specifications	38
Table 4-1: Troubleshooting	44

EU Declaration of Incorporation

Manufacturer Aerotech, Inc.
101 Zeta Drive
Pittsburgh, PA 15238-2811
USA

herewith declares that the product:

AGV-SPO scan head

is intended to be incorporated into machinery to constitute machinery covered by the Directive 2006/42/EC as amended; and that the following harmonized European standards have been applied:

EN ISO 12100:2010

Safety of Machinery - Basic concepts, general principles for design

EN 60204-1:2010

Safety of Machinery - Electrical equipment of machines - Part 1: General requirements

and further more declares that

it is not allowed to put the equipment into service until the machinery into which it is to be incorporated or of which it is to be a component has been found and declared to be in conformity with the provisions of the Directive 2006/42/EC and with national implementing legislation, for example, as a whole, including the equipment referred to in this Declaration.

This is to certify that the aforementioned product is in accordance with the applicable requirements of the following directive(s):

EU 2015/863

Directive, Restricted Substances (RoHS 3)

**Authorized
Representative:**

Managing Director
Aerotech GmbH
Gustav-Weißkopf-Str. 18
90768 Fürth
Germany



Jochen Jäger

**Engineer Verifying
Compliance:**

Aerotech, Inc.
101 Zeta Drive
Pittsburgh, PA
15238-2811
USA

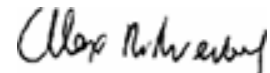

Alex Weibel

Date: 2/27/2025

UKCA Declaration of Incorporation

Manufacturer Aerotech, Inc.
101 Zeta Drive
Pittsburgh, PA 15238-2811
USA

herewith declares that the product:

AGV-SPO scan head

To which this declaration relates, meets the essential health and safety requirements and is in conformity with the relevant UK Legislation listed below:

Supply of Machinery (Safety) Regulations 2008

Hazardous Substances in Electrical and Electronic Equipment Regulations 2012

Using the relevant section of the following UK Designated Standards and other normative documents when installed in accordance with the installation instructions supplied by the manufacturer.

EN ISO 12100:2010

Safety of Machinery - Basic concepts, general principles for design

EN 60204-1:2010

Safety of Machinery - Electrical equipment of machines - Part 1: General requirements

and furthermore declares that it is not allowed to put the product into service until the machinery into which it is to be incorporated or of which it is to be a component has been found and declared to be in conformity with the provisions of the Supply of Machinery (Safety) Regulations 2008 UK Legislation and with national implementing legislation, for example, as a whole, including the equipment referred to in this Declaration.

Authorized Representative:

Managing Director
Aerotech Ltd.
The Old Brick Kiln
Ramsdell, Tadley
Hampshire RG26 5PR
UK



Simon Smith

Engineer Verifying Compliance:

Aerotech, Inc.
101 Zeta Drive
Pittsburgh, PA
15238-2811
USA



Alex Weibel

Date: 2/27/2025

This page intentionally left blank.

Safety Procedures and Warnings



IMPORTANT: This manual tells you how to carefully and correctly use and operate the scan head.

- Read all parts of this manual before you install or operate the scan head or before you do maintenance to your system.
- To prevent injury to you and damage to the equipment, obey the precautions in this manual.
- All specifications and illustrations are for reference only and were complete and accurate as of the release of this manual. To find the newest information about this product, refer to www.aerotech.com.

If you do not understand the information in this manual, contact Aerotech Global Technical Support.



IMPORTANT: This product has been designed for light industrial manufacturing or laboratory environments. If the product is used in a manner not specified by the manufacturer:

- The protection provided by the equipment could be impaired.
- The life expectancy of the product could be decreased.

Safety notes and symbols are placed throughout this manual to warn you of the potential risks at the moment of the safety note or if you fail to obey the safety note.



Shock/Electrocution Hazard



Pinch, Shear, or Crush Hazard



General/Conditional Awareness



Rotational Machinery Hazard



Hot Surface Hazard



Pinch/Entanglement Hazard



Magnetic Field Hazard



Trip Hazard



Heavy, Bulky Lifting Hazard



Laser Hazard



Pressure/Explosive Atmosphere Hazard



Electrostatic Discharge Hazard

A blue circle symbol is an action or tip that you should obey. Some examples include:



General tip



Read the manual/section



Wear personal protective equipment (PPE): Safety Glasses



If applicable, do not lift unassisted



Wear personal protective equipment (PPE): Gloves



Wear personal protective equipment (PPE): Hearing Protection

Installation and Operation

To decrease the risk of damage to the equipment, you must obey the precautions that follow.



DANGER: General Hazard Warning!

This product can produce high forces and move at velocities that could cause injury. The user is responsible for its safe operation. The following general equation is provided to assist with risk assessments in regards to contact and pinch points:

$$Pressure_{Max} \left[\frac{N}{mm^2} \right] = \frac{Force_{Peak} [N]}{Area_{Contact} [mm^2]}$$



WARNING: General Hazard Warning!

- Only trained operators should operate this equipment.
- All service and maintenance must be done by approved personnel.
- Use this product only in environments and operating conditions that are approved in this manual.
- Never install or operate equipment that appears to be damaged.
- Make sure that the product is securely mounted before you operate it.
- Use care when you move the scan head or you could negatively affect the performance of it.



WARNING: Trip Hazard!

Route, house, and secure all cables, duct work, air, or water lines. Failure to do so could introduce trip hazards around the system that could result in physical injury or could damage the equipment.

Laser Safety

It is the responsibility of the user to provide the necessary conditions for safe operation of a laser system and to safeguard the work area against the dangers that can be caused by laser radiation. The user must ensure compliance with all local and national regulations.

Although the scan head by itself does not emit laser radiation, the user must undertake a thorough analysis of system safety before they operate the AGV-SPO in conjunction with a laser source. Important information for performing this analysis is presented in this manual. Look for additional information in the corresponding documentation supplied by the manufacturer(s) of the laser source and other system components.

Classes of Lasers

The AGV-SPO series scan head can be used with a variety of lasers. Each laser is assigned a particular hazard level, which is indicated by the Laser Class label that is affixed to the device near the location where laser radiation is emitted. Brief descriptions of each of the various radiation classes are presented in the table below.

Note that in addition to the dangers of radiation, lasers can pose further dangers, such as the risk of electrical shock or the generation of poisonous fumes.

Classifications of Laser Devices

	Class	Danger
	Class I	Inherently safe; no possibility of eye damage during normal operation.
	Class IIa	Requires in excess of 1000 seconds of continuous viewing to cause eye damage.
	Class II	The blink reflex will prevent eye damage, unless the person deliberately stares into the beam for an extended period of time.
	Class IIIa	Mostly dangerous in combination with optical instruments which change the beam diameter or power density. However, even without optical enhancement, direct contact for over two minutes could cause eye damage.
	Class IIIb	Direct exposures of 0.01 second or less could cause eye and skin damage.
	Class IV	Direct or scattered radiation without optical enhancement could cause eye and skin damage.

Laser Area

The area in which the maximum permitted radiation value can be exceeded is defined as the laser area. In general, a laser area is applicable to Class IIIa, IIIb and IV laser systems. A laser area can also be produced if you focus the beam of a Class I, IIa, or II laser device.

The AGV-SPO can aim the laser beam over an approximately pyramidal volume. When the scan head is used in conjunction with a laser device that can generate a sufficiently intense beam, a laser area will be produced that includes the aiming volume as well as the reflections from all objects that can be exposed to the radiation. It is important to note that even apparently diffuse surfaces can reflect laser radiation and a laser beam that has been reflected several times can still be dangerous.

The laser area must be designated by suitable warning signs or lamps and protected by appropriate shading and interlock switches.

Figure 1: Generic Example of a Laser System including an AGV-SPO Scan Head and its Work Area

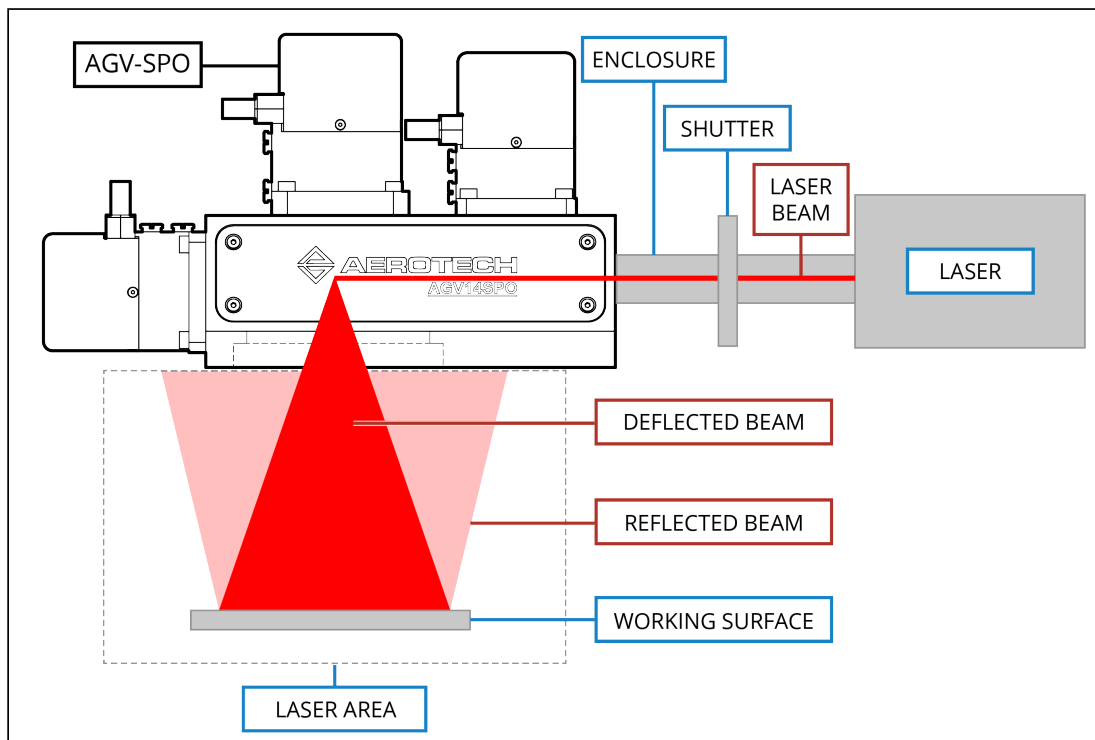

Laser Shutter

A laser attenuator (beam shutter) is a mechanical or electrical device that blocks the emission of laser radiation. It is a requirement for most classes of laser systems. The attenuator must be available for use at all times when the laser system is operated. Power switches and key controls do not satisfy the attenuator requirement.

The AGV-SPO scan head does not include a laser attenuator, and therefore it cannot block or reduce the intensity of the laser beam. Due to the unique properties of each laser, it is the responsibility of the user to incorporate an appropriate shutter as per any and all applicable regulations in order to prevent unwanted emission of the laser beam.

Place the beam shutter between the laser source and the scan head (refer to [Figure 1](#)).



DANGER: The danger to your eyes increases when optical instruments are used in conjunction with the scan head.



- Wear certified laser safety eye protection.
- Do not stare into the laser beam, put your body parts in the laser area, or expose yourself to reflections from powerful beams.



WARNING: Aerotech recommends that you only use a Class 1 HeNe laser to do alignments. If a Class 1 HeNe laser is not available, use the lowest power setting on the available laser and remote beam sensing techniques.

Electrical Warnings

To decrease the risk of electrical shock, injury, death, and damage to the equipment, obey the precautions that follow.



DANGER: Electrical Shock Hazard!

- Scan head motor phase voltage levels could be hazardous live.
- Personnel are protected from hazardous voltages unless electrical interconnections, protective bonding (safety ground), or motor/scan head enclosures are compromised.
- Do not connect or disconnect scan head/motor interconnections while connected to a live electrical power source.
- Before you set up or do maintenance, disconnect electrical power.
- It is the responsibility of the End User/System Integrator to make sure that scan heads are properly connected and grounded per Engineering Standards and applicable safety requirements.
- It is the responsibility of the End User/System Integrator to configure the system drive or controller within the Aerotech motor/scan head electrical and mechanical specifications.

Motor-Related Warnings

Aerotech motors are capable of producing high forces and velocities. Obey all warnings and all applicable codes and standards when you use or operate a system that incorporates Aerotech motors.



DANGER: Mechanical Hazard!

Personnel must be made aware of the mechanical hazards during set up or when you do service to the scan head.



- Unintentional manual movement into the end-of-travel stops, could damage the scan head or undo precision alignments.
- Scan head movement could create pinch points, entanglement hazards, or rotational mechanical hazards.



DANGER: Hot Surface Hazard!

- The scan head/motor frame temperature could exceed 70°C in some applications.
- Do not touch the frame while it is in operation.
- Wait until the scan head has cooled before you touch it.



DANGER: Risk in Explosive Atmosphere!

- Standard Aerotech scan head/motors are not rated for applications with explosive atmospheres such as airborne dust or combustible vapors.
- Do not operate this product outside of Aerotech environmental specifications.



DANGER: Magnetic Field Hazard!

Aerotech motors contain magnets which can present a Magnetic Field Hazard.

- Do not disassemble a motor under any circumstances.
- Strong magnetic fields could interfere with external/internal medical devices.
- Strong magnetic fields could present mechanical hazards such as pinch points.

Pinch Points

A pinch point is a mechanical hazard that can occur when there are exposed parts of the scan mirrors or system that can move. For example, the travel of a stage tabletop could expose the user to a pinch point between the tabletop and the stage housing.

DANGER: Pinch Point Hazard!



- System travel can cause crush, shear, or pinch injuries.
- Restrict access to the Beam Exit Aperture to avoid pinch points around the scan mirrors.
- Do not lift by the cables.
- Only trained operators should operate this equipment.
- Do not put yourself in the travel path of machinery.
- Restrict access to all motor and scan head parts
 - when the system moves under power (during normal operation, for example).
 - when the system is moved manually (during the installation process or when you do maintenance, for example).
- Motors are capable of very high speeds and acceleration rates.

Figure 2: Typical Pinch Point Location

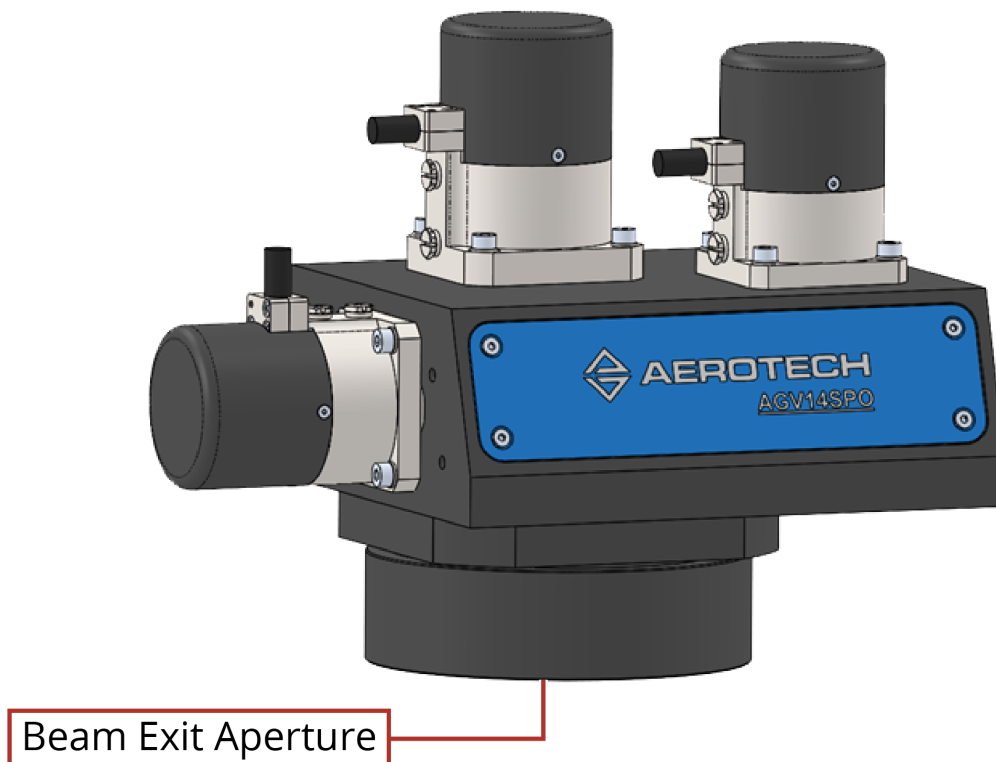

Handling and Storage



IMPORTANT: Before you open the container:

- To prevent the accumulation of condensation on the optical surfaces, allow the shipping case to sit at room temperature for 24 hours.
- The container should only be opened in a clean, dust-free environment.
- All electronic equipment and instrumentation is wrapped in antistatic material and packaged with desiccant. Ensure that the antistatic material is not damaged during unpacking.
- Wear clean, powder-free gloves when you handle optical components.



WARNING: It is the responsibility of the customer to safely and carefully lift and move the scan head. If you are not careful, you could adversely affect the performance of the AGV-SPO.

- Do not use the cables or tubing as lifting points.
- Do not use the focal lens or exit aperture as a lift surface.
- Make sure that the lens cap is attached before you move the AGV-SPO.
- Put the scan head on a soft surface when it is not attached to its mounting surface to protect the optics.
- Refer to [Section 1.3. Basic Specifications](#) for weight specifications
- Refer to [Section 2.1. Scanner Dimensions](#) for dimensions

Inspect the shipping container for any evidence of shipping damage. If any damage exists, notify the shipping carrier immediately.

Remove the packing list from the shipping container. Make sure that all the items specified on the packing list are contained within the package.

The documentation for the scan head is on the included installation device. The documents include manuals, interconnection drawings, and other documentation pertaining to the system. Save this information for future reference.

Each scan head has a label listing the system part number and serial number. These numbers contain information necessary for maintenance or system hardware and software updates. Locate this label and record the information for later reference.

Unpacking and Handling



WARNING: Electrostatic Discharge (ESD) Sensitive Components!

Wear an ESD wrist strap when you handle, install, or do service to the system assembly.

Failure to observe the correct ESD practices could cause ESD damage to stage electronics, system drives, and/or power supplies.



IMPORTANT: It is the responsibility of the customer to safely and carefully lift and move the scan head.

- Be careful when you move or transport the scan head.
- Retain the shipping materials for future use.
- Transport or store the scan head in its protective packaging.



IMPORTANT: Wear clean, powder-free gloves when you handle optical components.

Lift only by the base of the scan head. **Do not lift by the motors or cables.**

Storage

Store the scan head in the original shipping container. If the original packaging included ESD protective packaging, make sure to store the scan head in it. The storage location must be dry, free of dust, free of vibrations, and flat.

Refer to [Section 1.1. Environmental Specifications](#)

Chapter 1: Overview

A 2-axis galvanometer scanner is used to deflect a laser beam in the X and Y directions. The laser can be directed to any position within the two-dimensional area, which is called the “marking field”. The single pivot-point galvanometer scanner directs the beam so that the pivot point for the X direction is at the same point in space as the pivot point for the Y direction. This is accomplished by rotating 3 turning mirrors, each of which is actuated by a galvo motor. Every scan head includes a beam entrance aperture and a beam exit aperture. Only suitable lasers of the appropriate wavelength, power level, beam diameter, etc., should enter the beam input aperture. Contact the factory for mirror and coating details. Depending on the options selected for the particular scan head, the beam exit aperture may be either open or fitted with a focal lens.

Figure 1-1: Single Point Scanner Component Diagram

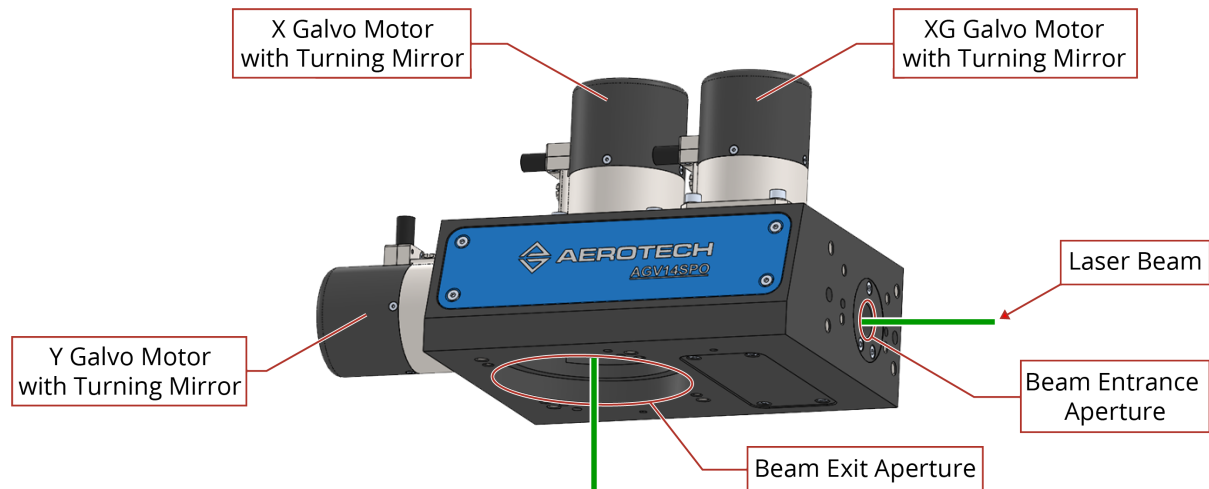

The AGV-SPO control connections consist of three 300 mm cables terminated in 25-pin D-style connectors.

Figure 1-2: Standard AGV-SPO

Scan Head
Motor Connectors

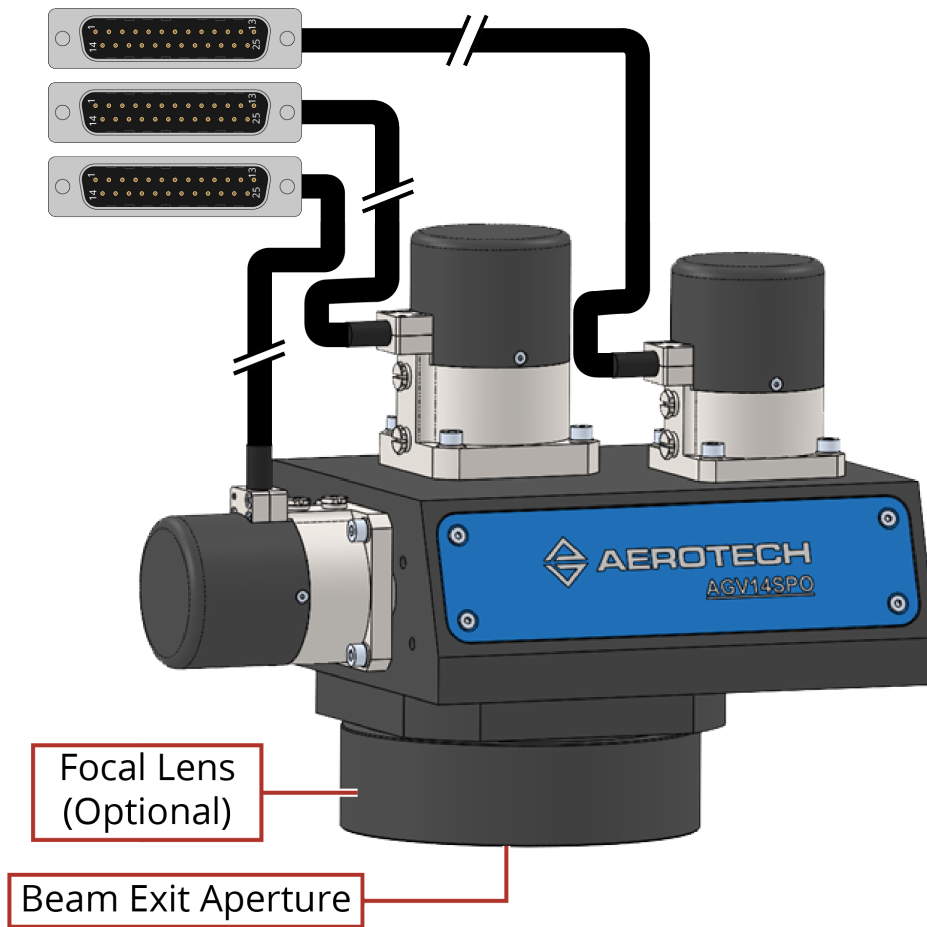

Table 1-1: Ordering Options

AGV-SPO High-Performance Single Pivot-Point Laser Scan Head	
AGV14SPO	2-axis single pivot point galvanometer scanner with 14 mm diameter beam aperture and integral high-precision feedback
Wavelength of Mirror Coating⁽¹⁾ (Required)	
-W001	10.6 μm
-W004	1064 nm
-W006	532 nm
-W008	355 nm
-W009	343 nm
NOTE: Custom coatings available. Contact factory for details.	
F-Theta Lenses Available (Optional)	
-Lxx	Contact the factory for F-Theta Lens options
Air Cooling (Optional, refer to Section 2.5.)	
-AC	Air cooling
Water Cooling (Optional, refer to Section 2.6.)	
-WC	Water cooling
Lens Mounting Adapter (To be Ordered as a Separate Line Item)	
LMxx	Lens mounting adapter for AGV14SPO. Standard versions support the lens configurations offered by Aerotech. Custom versions available upon request.

1.1. Environmental Specifications



WARNING: Use this product only in environments and operating conditions that are approved in this manual.

Table 1-2: Environmental Specifications

Ambient Temperature	The optimal operating temperature is 20 °C \pm 2 °C (68 °F \pm 4 °F). If at any time the operating temperature deviates from 20 °C degradation in performance could occur.
	Storage: 0 °C to 40 °C (32 °F to 104 °F) in original shipping packaging
Humidity	Operating: 20% to 60% RH
	Storage: 10% to 70% RH, non-condensing in original packaging. The scan head should be packaged with desiccant if it is to be stored for an extended time.
Altitude	Operating: 0 m to 2,000 m (0 ft to 6,562 ft) above sea level
	Contact Aerotech if your specific application involves use above 2,000 m or below sea level.
Vibration	Use the system in a low vibration environment. Excessive floor or acoustical vibration can affect system performance. Contact Aerotech for information regarding your specific application.
Protection Rating	The AGV-SPO has some protection from contamination due to laser marking and cutting processes. However, the scan head is not sealed. Dust and fumes generated by the laser machining process should be removed via an adequate exhaust or vacuum system. Failure to control this debris could result in damage to the scan head and the focal lens.
Use	Indoor use only

1.2. Accuracy and Temperature Effects

Aerotech products are designed for and built in a 20°C (68°F) environment. Extreme temperature changes could cause a decrease in performance or permanent damage to the AGV-SPO. At a minimum, the environmental temperature must be controlled to within 0.25°C per 24 hours to ensure the AGV-SPO specifications are repeatable over an extended period of time. The severity of temperature effects on all specifications depends on many different environmental conditions, including how the AGV-SPO is mounted. Contact the factory for more details.

1.2.1. Power-On Thermal Drift

For the best possible accuracy and repeatability, allow for a warm-up period of four hours after you connect the scan head to a powered controller. Power applied to the internal electronics of the scan head will increase its temperature and result in a transient period of "power-on" thermal drift. This warm-up period will provide the galvo motors sufficient time to achieve thermal equilibrium.

In applications where a mark-and-measure calibration is performed to improve accuracy, it is essential that the calibration procedure is not conducted prior to completion of the warm-up period. Otherwise, the calibration may not be effective due to the change in zero offset that can result from the "power-on" thermal drift.

To minimize delays in operating the AGV-SPO, it is recommended that the +5 V feedback power supply is continuously maintained to the galvo motors, even when they are not under servo control.

1.3. Basic Specifications

Table 1-3: AGV-SPO Series Specifications

		AGV14SPO
Optical Performance⁽¹⁾		
Beam Aperture		14 mm
Maximum Scan Angle		±20°
Beam Displacement		35 mm
Dither (Minimum Incremental Motion) ⁽²⁾		0.3 μrad _{RMS}
Accuracy		50 μrad pk-pk
Repeatability ⁽³⁾		0.6 μrad _{RMS}
Gain Error		0.05 mrad
Non-Linearity		0.005%
Dynamic Performance		
Tracking Error		0 μsec
Peak Acceleration ^(4,5)		60,000 m/s ²
Continuous Acceleration ^(4,6)		20,000 m/s ²
Positioning Speed ⁽⁴⁾		50 m/s
Marking Speed ^(4,7,8)		5 m/s
Jump & Settle Time, 1 mm Move ^(4,9)		700 μsec
Stability		
Long-Term Drift ⁽³⁾	Offset	10 μrad/12 hrs
		15 μrad/24 hrs
Thermal Drift	Gain	10 ppm/24 hrs
	Offset	20 μrad/°C
	Gain	1 ppm/°C
Mechanical Specifications		
Mass		5.1 kg
Material		Aluminum (Black Anodize and Blue Paint)
Mean Time Before Failure		20,000 Hours
<p>NOTE: All specifications are per axis unless noted.</p> <p>(1) All angles are optical unless otherwise noted.</p> <p>(2) Without -AC air cooling option.</p> <p>(3) After an initial four hour warm-up, expect an ambient temperature variation of < ±0.5°.</p> <p>(4) Typical performance with f = 160 mm F-Theta objective.</p> <p>(5) Based on the maximum rated current of the motor.</p> <p>(6) Based on the rated rms current of the motor with -WC water cooling option; maximum continuous acceleration is 70% of this value without water cooling.</p> <p>(7) Achievable with <1% velocity error over continuous velocity portion of move.</p> <p>(8) Marking speed is dependent on allowable tracking error.</p> <p>(9) Settled to within 1% of move distance.</p>		

Table 1-4: Mirror Specifications

	Cooling Option	Wavelength of Mirror Coating				
		-W001	-W004	-W006	-W008	-W009
Maximum CW Laser Power (W)	No Cooling	200	200	50	50	50
	Air Cooling	400	400	100	100	100
	Air and Water Cooling	1200	1200	300	300	300

1.4. Vacuum Operation

Contact the factory for information about operation in a vacuum environment.

Chapter 2: Mechanical Specifications and Installation

IMPORTANT: This manual tells you how to carefully and correctly use and operate the scan head.



- Read all parts of this manual before you install or operate the scan head or before you do maintenance to your system.
- To prevent injury to you and damage to the equipment, obey the precautions in this manual.
- All specifications and illustrations are for reference only and were complete and accurate as of the release of this manual. To find the newest information about this product, refer to www.aerotech.com.

If you do not understand the information in this manual, contact Aerotech Global Technical Support.



DANGER: Use of this product increases the risk of exposure to visible and/or invisible laser radiation.

- Do not stare into the laser beam, put your body parts in the laser area, or expose yourself to reflections from powerful beams.
- Wear certified laser safety eye protection.
- Avoid eye or skin exposure to direct or scattered radiation.



WARNING: Aerotech recommends that you only use a Class 1 HeNe laser to do alignments. If a Class 1 HeNe laser is not available, use the lowest power setting on the available laser and remote beam sensing techniques.



WARNING: Use the parameter file provided by the factory to configure the controller or permanent mechanical damage could occur.

2.1. Scanner Dimensions

Figure 2-1: AGV14SPO Galvanometer Scanner Dimensions

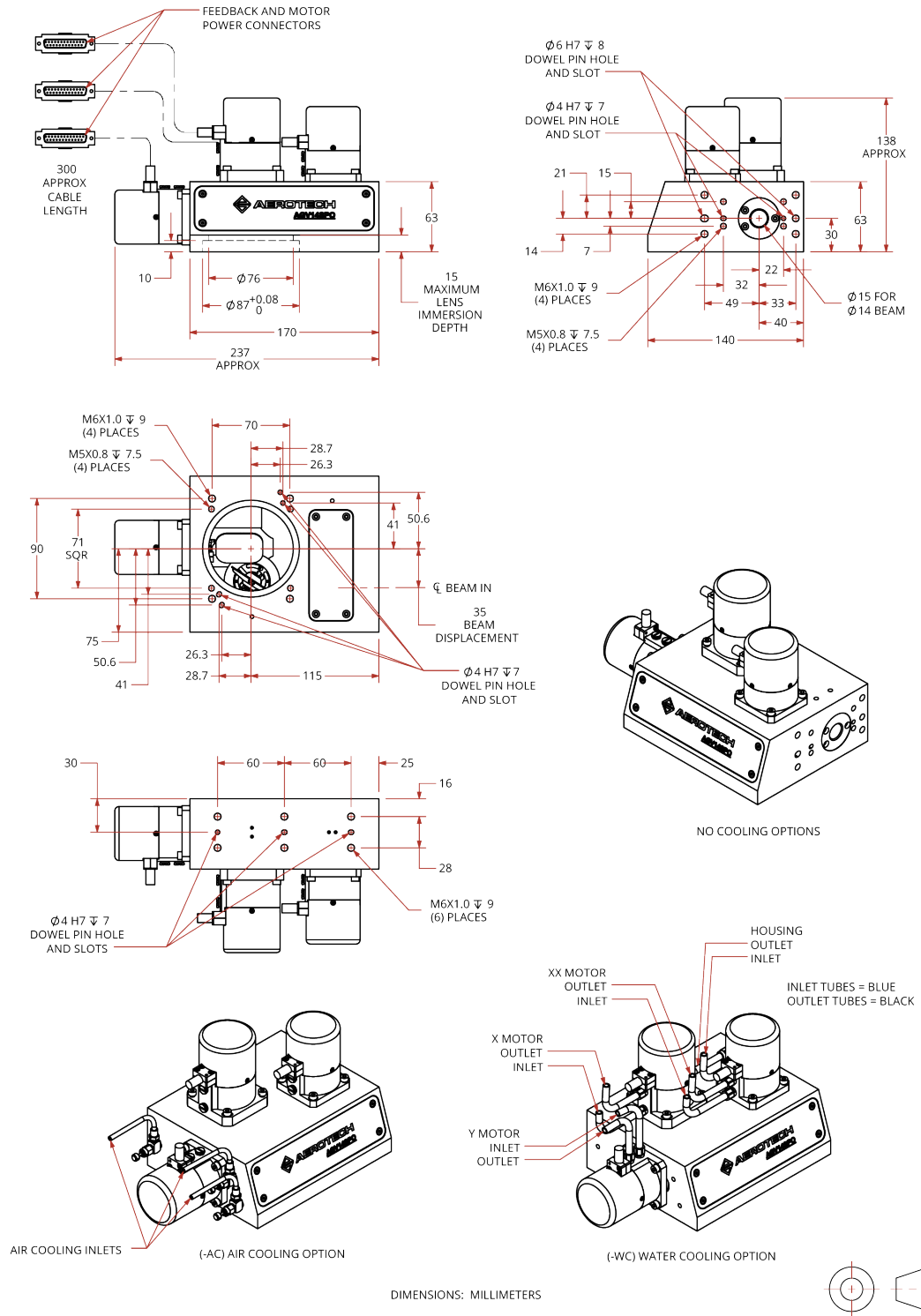

2.2. Optical Dimensions

Figure 2-2: AGV-SPO Optical Dimensions

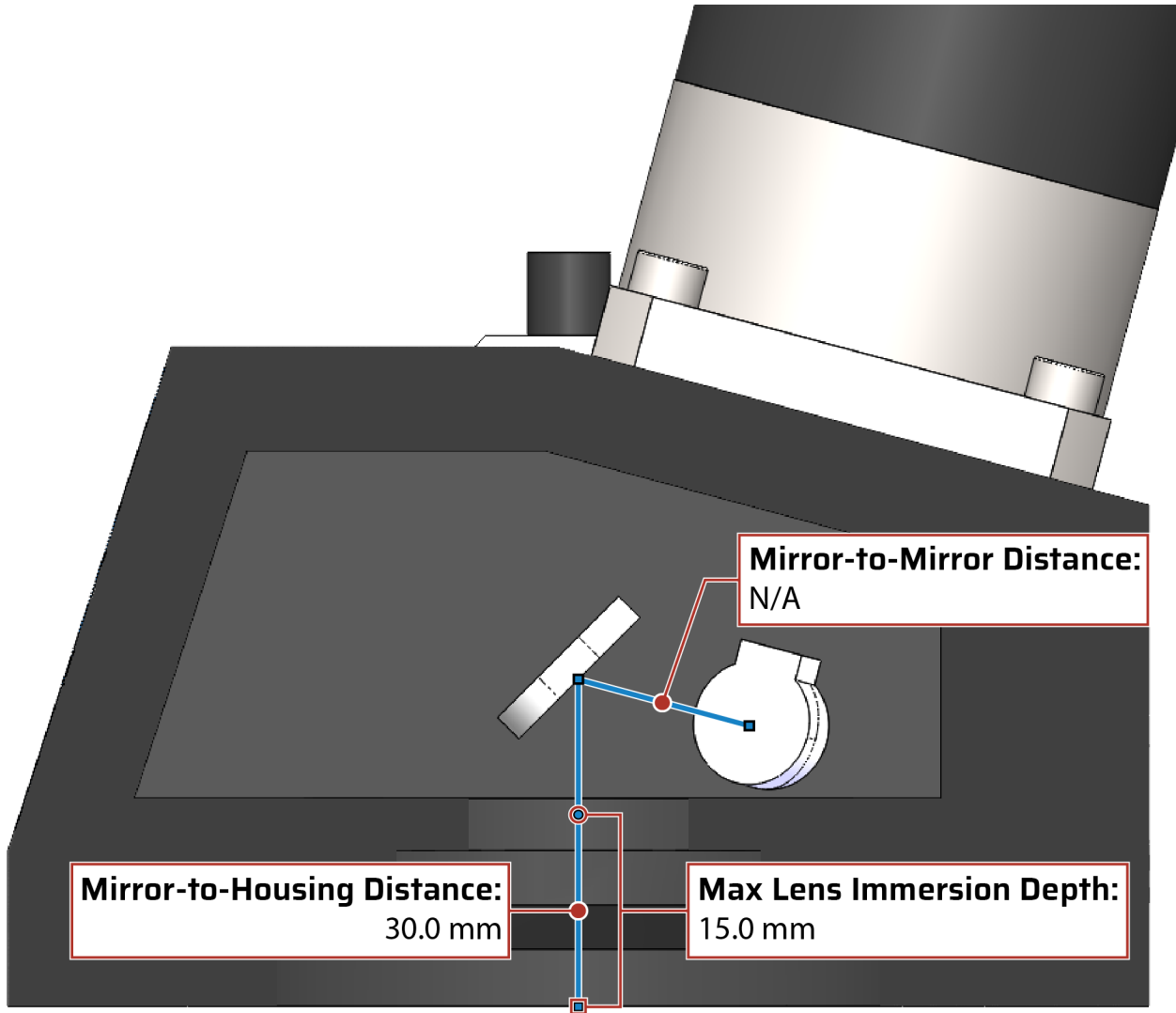

2.3. Securing the Scan Head to the Mounting Surface



WARNING: It is the responsibility of the customer to safely and carefully move and mount the scan head. If you are not careful, you could adversely affect the performance of the AGV-SPO.

- Make sure that the lens cap is attached before you move the AGV-SPO.
- Put the scan head on a soft surface when it is not attached to its mounting surface to protect the optics.

The mounting surface should be flat and have adequate stiffness in order to achieve the maximum performance from the AGV-SPO scan head. When an AGV-SPO is mounted to a non-flat surface, the scan head can be distorted as the mounting screws are tightened. This distortion will affect the alignment between the galvo motors and decrease the overall accuracy of the scan head. Adjustments to the mounting surface must be made before the scan head is secured.

Inspect the mounting surface for dirt or unwanted residue and clean if necessary. Use precision flatstones on the mounting surface to remove any burrs or high spots. Clean the mounting surface with a lint-free cloth and acetone or isopropyl alcohol and allow the cleaning solvent to completely dry. Gently place the scan head on the mounting surface.



WARNING: The AGV-SPO is precision machined and verified for flatness at the factory.

- Do not machine the AGV-SPO housing. If you must machine a surface to achieve a required flatness, machine the mounting surface.
- Keep the use of shims to a minimum when you mount the AGV-SPO to the mounting surface. The use of shims could reduce the rigidity of the system.

The parallelism of the AGV-SPO focus plane to the physical work plane is important for deterministic spot sizes in the work plane. The required alignment precision between the AGV-SPO and the work plane are dependent on the working distance and depth of focus of the optical system. The alignment tolerance should be based on the variability acceptable in the optical system. Aerotech recommends that you align the bottom surface of the AGV parallel to the work plane within 25 μm as a starting point.



WARNING: To maintain accuracy, the mounting surface must be flat to within 3 μm per 50 mm.

There are several ways to mount the AGV-SPO scan head. Attaching the scan head directly with the mounting holes provided on the beam entrance plate of the head uses the least amount of hardware. Additional mounting holes are also provided on the back surface of the scan head.

Refer to [Section 2.1](#) for dimensional drawings that detail the mounting hole locations, quantity, and size.

Attach the Scan Head to the Mounting Flange

A general procedure for attaching the AGV-SPO scan head to a mounting flange is provided below. Note that the mounting flange must include appropriate features to match the threaded holes and the dowel holes and slots present on the AGV-SPO scan head.

1. Remove the plug from the beam entrance aperture of the scan head.



IMPORTANT: Retain the plug for future use. Reinstall the plug if you need to ship the scan head back to the factory for service.

2. Prepare the mounting flange and the mating surface of the scan head by stoning with precision flatstones to remove any burrs or high spots.
3. Clean the mounting flange and the mating surface of the scan head with the appropriate cleaners (isopropyl alcohol for the scan head).
4. Line up the dowel hole and slot features of AGV-SPO scan head with the dowel pins protruding from the mounting flange.
5. Install the scan head onto the pins.
6. Insert the appropriate hardware into the holes of the mounting flange. The screw length must be long enough to provide at least 1.0x diameter thread engagement.
7. Using an appropriate wrench, tighten the hardware. Alternate tightening of the screws so that the AGV-SPO scan head comes together evenly on the mounting flange.

2.4. Attaching the Focal Lens to the Scan Head



IMPORTANT: Wear clean, powder-free gloves when you handle optical components.

The procedure outlined in this section is provided as a general reference for how to remove or install a focal lens (F-Theta lenses). A lens adapter is required to attach the focal lens to the AGV-SPO series scan head. This lens adapter is supplied with optics configurations that include a focal lens. For AGV-SPO scan heads that are provided without a focal lens, the user is responsible for supplying both the F-Theta lens and the necessary lens adapter. Contact the factory for assistance with the design of an appropriate lens adapter if necessary.

Figure 2-3: Example of F-Theta Lens (Complete Assembly)

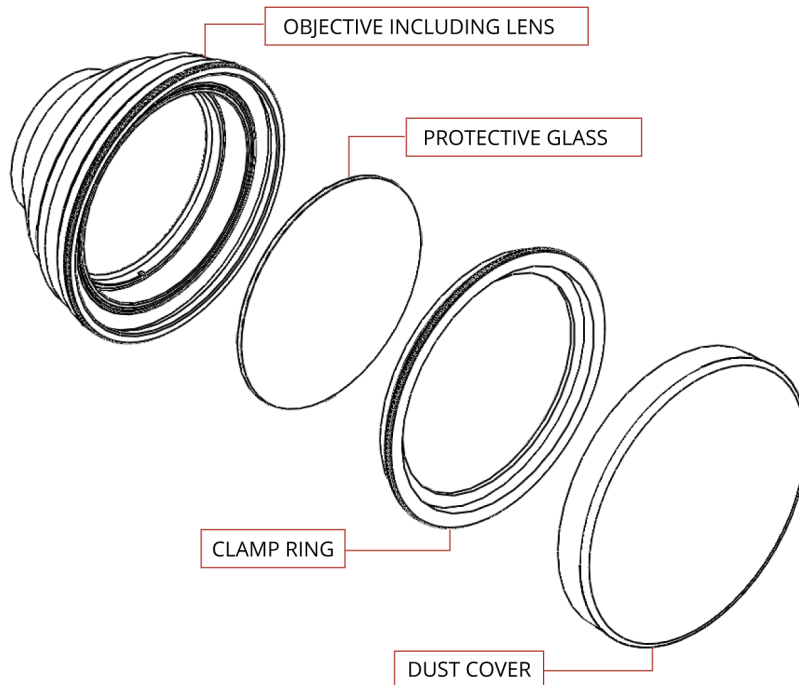

DANGER: Make sure that the laser is set in the "off" position and secured against accidental operation before you inspect or do maintenance to the focal lens.

Attach the Focal Lens to the Scan Head

1. Before you assemble the focal lens into the scan head, remove the dust cover(s) and inspect the lens elements and protective glass for dirt, scratches or cracks. Any lens component with a scratch or a crack must be replaced.
2. If the optics are dirty, use the procedure outlined in [Section 4.2](#) to clean them.
3. If necessary, use the clamp ring to install the protective glass over the front of the lens. Place the dust cover over the front of the lens.
4. Remove the plug from the beam exit aperture on the bottom of the scan head.
5. Make sure that the dowel pin in the lens adapter is aligned with the reference slot in the scan head and attach the lens adapter to the scan head using the appropriate hardware. The screw length must be long enough to provide at least 1.0x diameter thread engagement.
6. Screw the focal lens into the lens adapter until it seats and is positioned securely. Be careful not to cross-thread the housing of the lens assembly.
7. Remove the dust cover from the front of the focal lens.

To remove the focal lens, reverse the procedure outlined above.

Figure 2-4: Assembly of Focal Lens to Scan Head

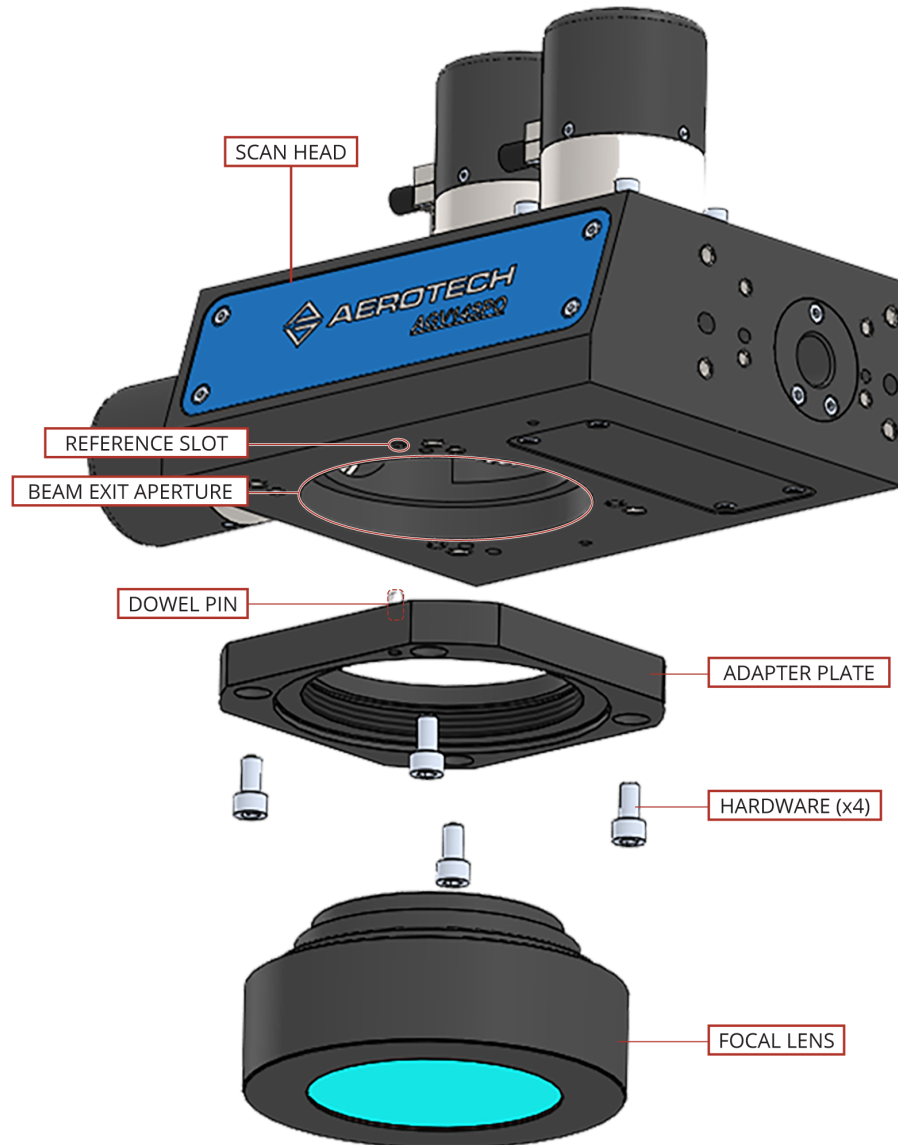

2.5. Air Requirements



WARNING: To prevent damage to the AGV-SPO, do not attach a water hose to an air fitting or an air hose to a water fitting.



DANGER: High pressure air can cause severe injury.

- Lock out the source and bleed off the pressure before you do service to the equipment.
- Wear eye protection.

An external air supply is required for AGV-SPO models equipped with the -AC air cooling option. This option provides cooling airflow to the turning mirrors. It does not actively cool the individual motors. The -WC option adds motor cooling components and verifies liquid-tight connections from the factory (refer to [Section 2.6.](#)).

Table 2-1: -AC Cooling Option Specifications

Connections	Use polyurethane (recommended) tubing with an outer diameter of 4 mm and inner diameter of 2.5 mm.
Gas Quality	Use clean, filtered gas: <ul style="list-style-type: none"> • If nitrogen is used, it must be 99.99% pure and filtered to 0.25 microns. [Recommended] • If compressed air is used, it must be filtered to 0.25 microns, dry to 0° F dew point, and oil free. NOTE: The filtration requirement is necessary to prevent particles and volatile hydrocarbons from damaging or contaminating the optical surfaces of the turning mirrors.
Nominal Flow Rate	20 SLPM (standard liters per minute) at 550 kPa (80 psi)
Maximum Pressure	586 kPa (85 psi)

Figure 2-5: Air-Cooling (-AC) Locations

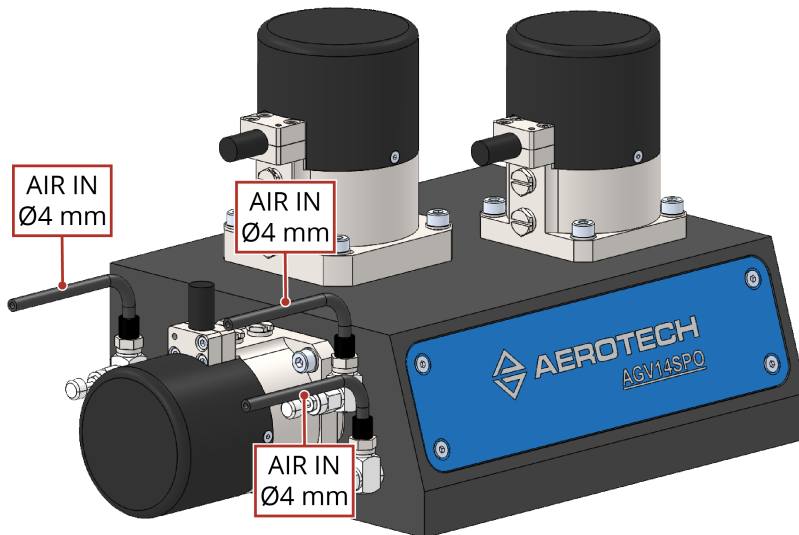

2.6. Water Requirements



WARNING: To prevent damage to the AGV-SPO, do not attach a water hose to an air fitting or an air hose to a water fitting.



WARNING: Use distilled water as the coolant in the AGV-SPO water-cooling system. **Do not** use deionized (DI) water. To prevent corrosion and damage to the cooling circuit, additives must be compatible with the materials found in the cooling circuit. These materials include brass, stainless steel, aluminum (bare or anodized), nickel plating, polyurethane, nylon, and nitrile rubber. If distilled water cannot be used, contact the factory to discuss the specifics of your application.

A supply of coolant is necessary for AGV-SPO models furnished with the -WC water cooling option. This option provides liquid cooling flow to the individual motors and to the main block. The AGV-SPO cooling circuits are leak-checked at the factory prior to shipment and the connections should not be modified.

Aerotech specifications were determined with the water cooling circuits connected in series.

Table 2-2: -WC Cooling Option Specifications

Connections	Use polyurethane (recommended) tubing with an outer diameter of 6 mm
	NOTE: Any additives used must be compatible with the tubing material.
Water Quality	Use distilled, temperature controlled water (required)
Filter	An in-line filter is recommended to avoid buildup of potential debris inside the scan head. A filter is not provided because it may affect the flow characteristics of an unknown cooling system. Aerotech suggests filtering to remove particles larger than 100 µm.
Chiller	Customer-Supplied. Make sure that the chiller can achieve the following Nominal Flow Rate while not exceeding the Maximum Pressure specification. NOTE: Aerotech does not endorse any specific pump or chiller technology. Aerotech's application development laboratory frequently uses turbine-pump chillers.
Nominal Flow Rate	1.3 liters per minute (0.35 gallons per minute)
Maximum Pressure	415 kPa (60 psid)
Maximum Required Cooling Capacity	600 W (application dependent)



IMPORTANT: The maximum motor current rating increases if water cooling is used (refer to Table 3-4).

Figure 2-6: Water Cooling (-WC) Locations

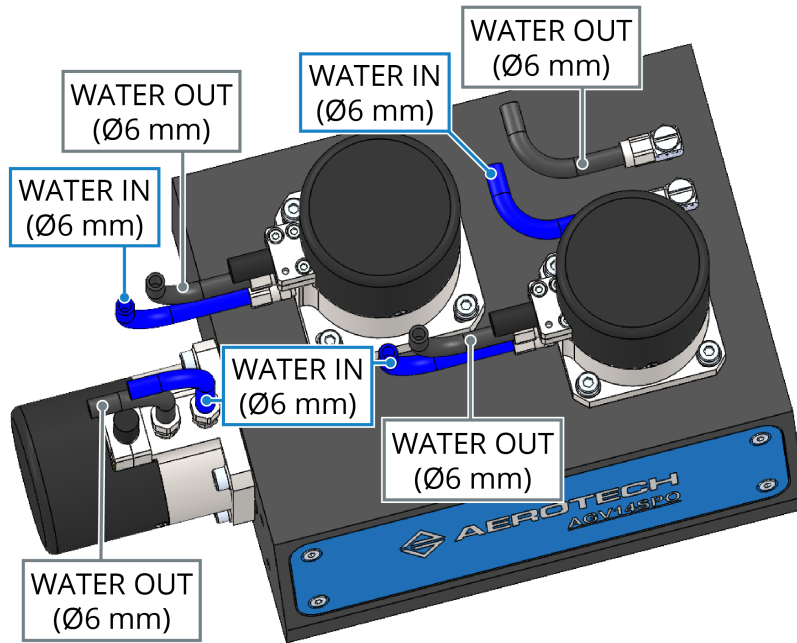

Chapter 3: Electrical Specifications and Installation

DANGER: Electrical Shock Hazard!



- Scan head motor phase voltage levels could be hazardous live.
- Personnel are protected from hazardous voltages unless electrical interconnections, protective bonding (safety ground), or motor/scan head enclosures are compromised.
- Do not connect or disconnect scan head/motor interconnections while connected to a live electrical power source.
- Before you set up or do maintenance, disconnect electrical power.
- It is the responsibility of the End User/System Integrator to make sure that scan heads are properly connected and grounded per Engineering Standards and applicable safety requirements.
- It is the responsibility of the End User/System Integrator to configure the system drive or controller within the Aerotech motor/scan head electrical and mechanical specifications.

WARNING: To prevent damage to the equipment and decrease the risk of electrical shock and injury, obey the precautions that follow.



- Only trained operators should operate this equipment.
- Use this product only in environments and operating conditions that are approved in this manual.

Electrical installation requirements will depend on the ordered product options. Installation instructions in this section are for Aerotech products equipped with standard Aerotech motors intended for use with an Aerotech motion control system. Contact Aerotech for further information on products that are otherwise configured.

Aerotech motion control systems are adjusted at the factory for optimum performance. When the AGV-SPO is part of a complete Aerotech motion control system, setup should only require that you connect the scan head to the appropriate drive chassis with the cables provided. Labels on the system components should indicate the appropriate connections.

If system level integration was purchased, an electrical drawing that shows the system interconnects has been supplied with the system (separate from this documentation).

The electrical wiring from the motor and encoder are integrated at the factory. Refer to the sections that follow for standard motor wiring and connector pinouts.

3.1. Motor Connectors

If the AGV-SPO is built with standard Aerotech motors and encoders, it will arrive from the factory completely wired and assembled.

AGV scan head motors use a single male 25-pin D-SUB connector (DB25P) for motor, encoder, and limit interconnections to a host controller. The pin assignments (pinout) of the controller match the pinout of Aerotech factory interface cables and controllers. For the scan head motor connector pinout, refer to [table Table 3-2](#).

The AGV scan heads contain galvo motors with dual analog encoder feedback. Both the primary and secondary position feedback signals of each galvo motor must be tuned for optimal performance. For help on how to adjust the gain, offset, and phase balance for each channel, refer to the Automation1 or A3200 Help system for more information. For controller information, refer to the Nmark GCL or GL4 Controller Hardware Manual for more information.

Table 3-1: Aerotech Standard Scan Head to Controller Cable Part Numbers

Application	Part Number
Standard	C23680-xxx ⁽¹⁾
Hi-Flex	C23690-xxx ⁽¹⁾

(1) The cable length (xxx) is in decimeters (1 decimeter = 3.937 inches). Contact Aerotech for the available cable lengths.

Table 3-2: Scan Head Motor Connector Pinout

Pin	Description	Connector
Case	Cable Shield	
1	SIN1+ (Encoder Sine 1+)	
2	COS1+ (Encoder Cosine 1+)	
3	5V Common Ground	
4	SIN2+ (Encoder Sine 2+)	
5	COS2+ (Encoder Cosine 2+)	
6	+/CW LMT (End-of travel limit signal that indicates maximum permitted travel in the “machine positive” or “machine clockwise” direction.)	
7	MRK+ (Encoder Marker+)	
8	Encoder 5V Supply Input	
9	Over-Temperature Thermistor Sensor	
10	Reserved	
11	Frame Ground	
12	Motor +	
13	Motor +	
14	SIN1- (Encoder Sine 1-)	
15	COS1- (Encoder Cosine 1-)	
16	5V Common Ground	
17	SIN2- (Encoder Sine 2-)	
18	COS2- (Encoder Cosine 2-)	
19	-/CCW LMT (End-of travel limit signal that indicates maximum permitted travel in the “machine negative” or “machine counter-clockwise” direction.)	
20	MRK- (Encoder Marker-)	
21	5V Common Ground	
22	5V Common Ground	
23	Frame Ground	
24	Motor -	
25	Motor -	

Table 3-3: Mating Connector Part Numbers for the Scan Head Motor Connector

Mating Connector	Aerotech P/N	Third Party P/N
25-Socket D-Connector	ECK00300	FCI DB25S064TLF
Backshell	ECK00656	Amphenol 17E-1726-2

3.2. Motor, Feedback, and Limit Specifications

All 5 V supplies share one common connection within the scan head.

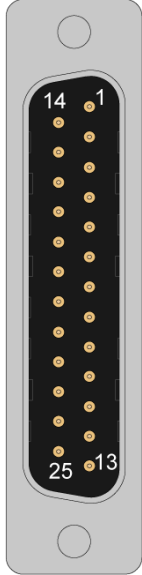
Table 3-4: Scan Head Motor and Feedback Specifications

Feedback Specifications		
	Y Motor, XG Motor	X Motor
Supply Voltage	5 V \pm 5%	
Supply Current	250 mA	
Output Signals	Sinusoidal Type (Incremental Encoder): 1 V _{pk-pk} into 120 Ω Load (differential signals SIN+, SIN-, COS+, COS- are .5 V _{pk-pk} relative to ground.)	
Encoder Resolution	4096 lines/revolution	
Motor Specifications		
	Y Motor, XG Motor	X Motor
BEMF Constant	1.4 V/krpm	4.3 V/krpm
Maximum Current	2.5 A _{rms}	
Maximum Current (with -WC)	4 A _{rms}	
Resistance	1.35 Ω	3.0 Ω
Inductance	0.18 mH	0.86 mH
Maximum Temperature	60 $^{\circ}$ C	
Maximum Bus Voltage	\pm 48 V	
Number of Poles	2	

Table 3-5: Thermistor Specifications

Thermistor Specifications	
Polarity	Logic "0" (no fault)
	Logic "1" (over-temperature fault)
Cold Resistance	\sim 100 Ω
Hot Resistance	\sim 10 k Ω
Note: 1 k Ω pull-up to +5V recommended.	

Table 3-6: Limit Switch Specifications

	Specification
Supply Voltage	5 V \pm 5%
Supply Current	25 mA
Output Type	Open Collector
Output Voltage	5 V
Output Current	10 mA (sinking)
Output Polarity (Factory Configured)	Normally Closed (NC) <ul style="list-style-type: none"> Sinks current to ground (Logic "0") when not in limit High impedance (Logic "1") when in limit Requires external pull-up to +5 V (10 kΩ recommended)
Note: If the AGV-SPO is driven beyond the electrical limit, it will encounter a mechanical stop. Impacting the mechanical stop could cause damage to the stage.	

3.3. Machine Direction

Aerotech scan heads are configured to have positive and negative "machine" directions. The machine direction defines the phasing of the feedback and motor signals and is dictated by the motor wiring (refer to [Section 3.4.](#) for Feedback phasing information). Programming direction of a scan head is set by the controller that is used to move the scan head. Programming direction is typically selectable in the controller, while machine direction is hardwired in the scan head.

Figure 3-1: Galvo X-Axis Machine Direction (front)

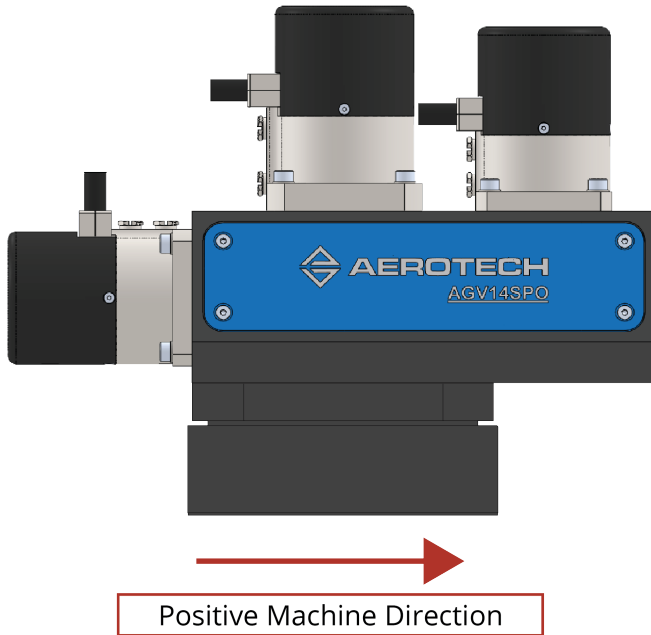
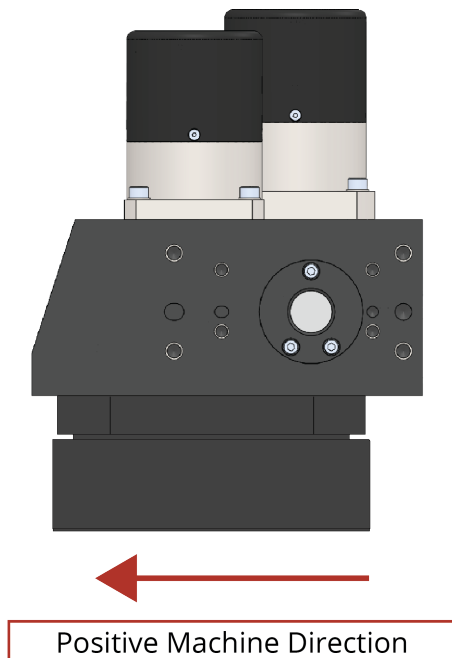

Figure 3-2: Galvo Y-Axis Machine Direction (side)



3.4. Feedback Phasing

Figure 3-3: Analog Encoder Phasing Reference Diagram

Incremental Two channels V_1 and V_2 differential sinusoids in quadrature, centred ~ 1.65 V (90° phase shifted)

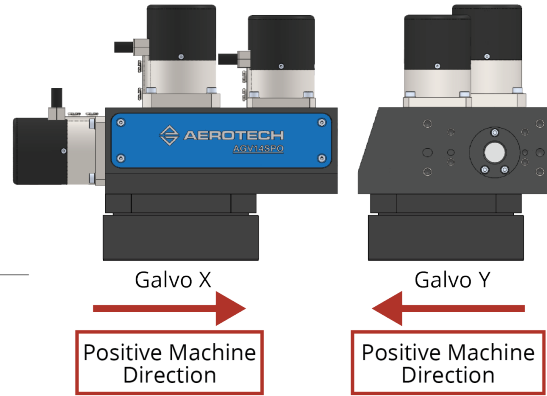
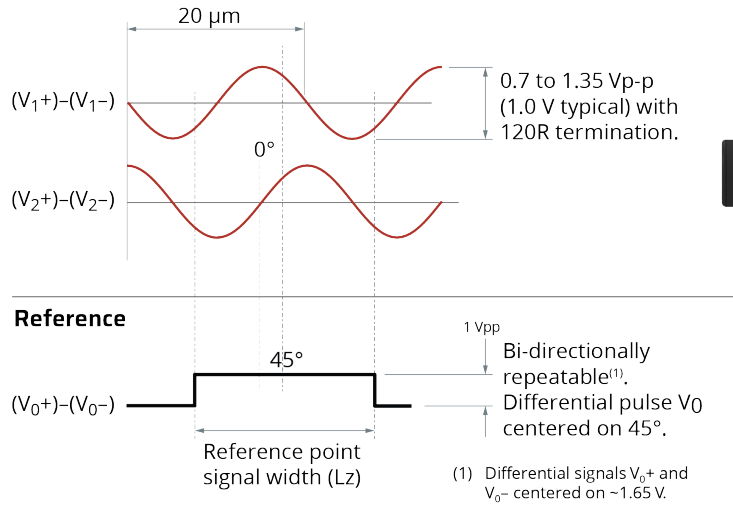

Chapter 4: Maintenance



IMPORTANT: AGV scan head products are optimized (“matched”) at the factory with a specific amplifier for maximum dynamic performance. In the event that service is required, both components and any associated interconnect cables should be returned so that the entire system can be re-optimized. The use of unmatched hardware may result in reduced performance compared to a factory-optimized system.



DANGER: To decrease the risk of electrical shock, injury, death, and damage to the equipment, obey the precautions that follow.

- All service and maintenance must be done by approved personnel.
- Before you do maintenance to the equipment, disconnect the electrical power.
- Before you connect wires to this product, disconnect the electrical power.
- Restrict access to the scan head when it is connected to a power source.



WARNING: Keep the scan head free of foreign matter and moisture to prevent a reduction in its performance and life expectancy.

The AGV-SPO series scan head is designed to be dust resistant except at the beam entrance and beam exit apertures. The scan head does not require any maintenance other than periodic cleaning. Included in this chapter are recommended cleaning solvents.



IMPORTANT: Laser-induced damage to the AGV-SPO turning mirrors is excluded from the standard product warranty.

4.1. Service and Inspection Schedule

Until you can determine the correct inspection interval for your system, set the interval for once a month. Use the system application(s) and conditions (duty cycle, speed, and environment) to define the inspection interval.

Monthly inspections should include but not be limited to:

- Visually inspect the galvo, components, and cables.
- Re-tighten loose connectors.
- Replace or repair damaged cables.
- Clean the galvo and any components and cables as needed.
- Repair any damage before you operate the galvo.
- Inspect and perform an operational check on all safeguards and protective devices.

It is usually not possible for Aerotech field service personnel to do repairs and/or replace components. Contact Aerotech Global Technical Support for more information and to determine if the AGV-SPO should be sent back to the factory for maintenance.

4.2. Cleaning and Lubrication

There are no elements on the scan head that require lubrication.

Before you use a cleaning solvent on any part of the AGV-SPO, blow away small particles and dust with nitrogen or, less preferably, clean, dry, compressed air.

Use isopropyl alcohol on a lint-free cloth to clean any external metal surface of the AGV-SPO.

4.2.1. Focal Lens and Protective Glass

Optical surfaces that are contaminated with dirt and debris result in increased absorption of laser radiation. Over time, this contamination can cause the optical surfaces to absorb enough heat to cause permanent burn damage. There are several different kinds of optical surface contamination:

- Airborne particles in the ambient atmosphere – dust, grease, etc.
- Products from the laser process – vapors, back spatter, burned-in particles, etc.
- Organic contamination – particles produced by talking, coughing, or sneezing near the optical surfaces.

Wherever possible, protect the exposed optics to avoid contamination. However, since contamination cannot be completely avoided, you will have to periodically clean the optical system. Regularly inspect and clean the optical surfaces to help prevent permanent damage.



WARNING: Contamination from the laser process can cause irreversible damage to the optical surfaces. To help minimize contamination, use a disposable protective glass window and/or an exhaust or vacuum system.

Optical materials and coatings are relatively soft substances and incorrect cleaning techniques will result in surface damage and drastically reduced component lifetime. The cleaning procedure for the AGV-SPO is intended to help prolong the component lifetime.



IMPORTANT: Wear clean, powder-free gloves when you handle optical components.



DANGER: Make sure that the laser is set in the "off" position and secured against accidental operation before you inspect or do maintenance to the focal lens.



WARNING: If the focal lens does not have a protective glass window, take extra care when you clean the focal lens.

General Cleaning Procedure

- Use compressed nitrogen or clean, dry, oil-less air to remove any loose particles from the surface.
- Moisten an appropriate lint-free lens cleaning cloth with isopropyl alcohol.
- Fold the cloth over such that one folded (straight) edge will serve as the leading edge during the wiping motion.
- Place the folded (straight) edge of the cloth onto one end of the optical surface. Applying very minimal pressure, slowly move the cloth over the optical component to the opposite end. Never bear down hard, scrub, or wipe in a circular motion when cleaning an optical surface.
- Remove any liquid residue with a dry lint-free lens cleaning cloth or by blow it off in one direction with compressed nitrogen or clean, dry, oil-less air.
- Repeat this procedure, using a new lint-free lens cleaning cloth for each repetition, until the surface is completely clean.

4.2.2. Turning Mirrors



WARNING: Never touch the reflective surface of a turning mirror. Turning mirror surfaces are extremely delicate and can be easily damaged.



IMPORTANT: Wear clean, powder-free gloves when you handle optical components.

The reflective surfaces of the turning mirrors are extremely sensitive and should only be cleaned when it is absolutely necessary and only by experienced personnel. In many cases, minor imperfections in the surface of the mirror can be less harmful than the surface damage caused by repeated cleaning.

Small quantities of particles could settle on the mirrors as a result of handling and general environmental conditions. You should remove them with a gentle, low-velocity flow of air (in accordance with the specifications in [Section 2.5.](#)). Direct the flow of air at a shallow angle of incidence to each mirror to minimize the risk of damage.

When cleaning the turning mirrors becomes an absolute necessity (to remove fingerprints from the reflective surfaces, for example), carefully follow the same procedure outlined in [Section 4.2.1.](#)

The AGV-SPO is a dynamically-optimized scan head and the turning mirrors are not field-replaceable. Contact the factory in the event of severe damage to the reflective surfaces.

4.3. Troubleshooting

Table 4-1: Troubleshooting

Symptom	Possible Cause	Possible Solution
Scanners will not move.	Controller trap or fault.	Refer to the controller documentation.
	Motor and Feedback connections	Refer to Section 3.1. and the controller documentation.
Scanners move uncontrollably	Gains not optimized	Refer to the controller documentation for tuning instructions.
	Encoder signals not optimized	Refer to the controller documentation for encoder tuning instructions.
	Motor and Feedback connections	Refer to Section 3.1. and the controller documentation
Scanners oscillate or squeal	Gains not optimized	Refer to the controller documentation for tuning instructions.
	Encoder signals not optimized	Refer to the controller documentation for encoder tuning instructions.
Reduction in power as the laser beam passes through the scan head	Optical surfaces contaminated with dirt and debris	Refer to Section 4.2.
	Optical surfaces damaged	Contact Aerotech service and/or a lens supplier.
AGV-SPO scanner does not find marker during homing cycle.	Motor and Feedback connections	Refer to Section 3.1. and the controller documentation.
	Mechanical stops have shifted	Contact Aerotech service.
Beam motion in the X-axis is irregular or does not seem to emanate from a single pivot point.	X and XG are not coordinated correctly	Implement axis coordination per the comments in the program included with the system documentation.
Axis home positions are not in the center of the marking field.	X or XG axis was homed with axis coordination active	Reset controller and Home axes prior to initializing axis coordination. Refer to the controller documentation for more information.

Appendix A: Warranty and Field Service

Aerotech, Inc. warrants its products to be free from harmful defects caused by faulty materials or poor workmanship for a minimum period of one year from date of shipment from Aerotech. Aerotech's liability is limited to replacing, repairing or issuing credit, at its option, for any products that are returned by the original purchaser during the warranty period. Aerotech makes no warranty that its products are fit for the use or purpose to which they may be put by the buyer, whether or not such use or purpose has been disclosed to Aerotech in specifications or drawings previously or subsequently provided, or whether or not Aerotech's products are specifically designed and/or manufactured for buyer's use or purpose. Aerotech's liability on any claim for loss or damage arising out of the sale, resale, or use of any of its products shall in no event exceed the selling price of the unit.

THE EXPRESS WARRANTY SET FORTH HEREIN IS IN LIEU OF AND EXCLUDES ALL OTHER WARRANTIES, EXPRESSED OR IMPLIED, BY OPERATION OF LAW OR OTHERWISE. IN NO EVENT SHALL AEROTECH BE LIABLE FOR CONSEQUENTIAL OR SPECIAL DAMAGES.

Return Products Procedure

Claims for shipment damage (evident or concealed) must be filed with the carrier by the buyer. Aerotech must be notified within thirty (30) days of shipment of incorrect material. No product may be returned, whether in warranty or out of warranty, without first obtaining approval from Aerotech. No credit will be given nor repairs made for products returned without such approval. A "Return Materials Authorization (RMA)" number must accompany any returned product(s). The RMA number may be obtained by calling an Aerotech service center or by submitting the appropriate request available on our website (www.aerotech.com). Products must be returned, prepaid, to an Aerotech service center (no C.O.D. or Collect Freight accepted). The status of any product returned later than thirty (30) days after the issuance of a return authorization number will be subject to review.

Visit [Global Technical Support Portal](#) for the location of your nearest Aerotech Service center.

Returned Product Warranty Determination

After Aerotech's examination, warranty or out-of-warranty status will be determined. If upon Aerotech's examination a warranted defect exists, then the product(s) will be repaired at no charge and shipped, prepaid, back to the buyer. If the buyer desires an expedited method of return, the product(s) will be shipped collect. Warranty repairs do not extend the original warranty period.

Fixed Fee Repairs - Products having fixed-fee pricing will require a valid purchase order or credit card particulars before any service work can begin.

All Other Repairs - After Aerotech's evaluation, the buyer shall be notified of the repair cost. At such time the buyer must issue a valid purchase order to cover the cost of the repair and freight, or authorize the product(s) to be shipped back as is, at the buyer's expense. Failure to obtain a purchase order number or approval within thirty (30) days of notification will result in the product(s) being returned as is, at the buyer's expense.

Repair work is warranted for ninety (90) days from date of shipment. Replacement components are warranted for one year from date of shipment.

Rush Service

At times, the buyer may desire to expedite a repair. Regardless of warranty or out-of-warranty status, the buyer must issue a valid purchase order to cover the added rush service cost. Rush service is subject to Aerotech's approval.

On-site Warranty Repair

If an Aerotech product cannot be made functional by telephone assistance or by sending and having the customer install replacement parts, and cannot be returned to the Aerotech service center for repair, and if Aerotech determines the problem could be warranty-related, then the following policy applies:

Aerotech will provide an on-site Field Service Representative in a reasonable amount of time, provided that the customer issues a valid purchase order to Aerotech covering all transportation and subsistence costs. For warranty field repairs, the customer will not be charged for the cost of labor and material. If service is rendered at times other than normal work periods, then special rates apply.

If during the on-site repair it is determined the problem is not warranty related, then the terms and conditions stated in the following "On-Site Non-Warranty Repair" section apply.

On-site Non-Warranty Repair

If any Aerotech product cannot be made functional by telephone assistance or purchased replacement parts, and cannot be returned to the Aerotech service center for repair, then the following field service policy applies:

Aerotech will provide an on-site Field Service Representative in a reasonable amount of time, provided that the customer issues a valid purchase order to Aerotech covering all transportation and subsistence costs and the prevailing labor cost, including travel time, necessary to complete the repair.

Service Locations

<https://www.aerotech.com/contact-sales.aspx?mapState=showMap>

USA, CANADA, MEXICO

Aerotech, Inc.
Global Headquarters

CHINA

Aerotech China
Full-Service Subsidiary

GERMANY

Aerotech Germany
Full-Service Subsidiary

TAIWAN

Aerotech Taiwan
Full-Service Subsidiary

UNITED KINGDOM

Aerotech United Kingdom
Full-Service Subsidiary

Appendix B: Revision History

Revision	Description
2.02	General update
2.01	Internal release
2.00	General update
1.00	New Manual

This page intentionally left blank.

Index

			E	
	#		Electrical Installation	35
2006/42/EC		6	Electrical Warnings	14
			EN 60204-1 2010	6-7
	A		EN ISO 12100 2010	6-7
Accuracy and Temperature Effects		22	EU 2015/863	6
air				
nitrogen		32	F	
Air Cooling Option Specifications		32	Feedback Specifications	38
Air Requirements		32	field service	41
Altitude		22	Focal Lens	30,42
Ambient Temperature		22		
Attaching the Focal Lens to the Scan Head		30	H	
attenuator		13	Handling	17
			Humidity	22
	B			
Basic Specifications		23	I	
beam shutter		13	Inspection	41
			Inspection Schedule	41
	C		isopropyl alcohol	41
Class I		11		
Class II		11	L	
Class IIa		11	label	17
Class IIIa		11	Laser Safety	11
Class IIIb		11	Limit Switch Specifications	38
Class IV		11	Lubrication	41
cleaning			lubrication	41
mounting surface		28		
solvents		41	M	
Cleaning		41	Maintenance	41
Cleaning Solvents			maximum permitted radiation value	12
Recommended		41	Motor Specifications	38
cleaning the turning mirrors		43	Motor-Related Warnings	15
compressed air		32	mounting surface	
coolant		33	cleaning	28
	D			
Dimensions		26-27	N	
Directive 2006/42/EC		6	nitrogen	32
			O	
			Optical Dimensions	27

Optical surfaces contaminated	42
Ordering Options	21

P

packing list	17
part number	17
Protection Rating	22
Protective Glass	42

S

Scanner Dimensions	26
Securing the Scan Head to the Mounting Surface	28
serial number	17
Service and Inspection Schedule	41
solvents	41
Specifications	
Air Cooling Option	32
Limit Switch	38
Thermistor Specifications	38
Water Cooling Option	33
Storage	17

T

Table of Contents	3
Temperature Effects	22
Thermistor Specifications	38
Turning Mirrors	43

V

Vacuum Operation	24
Vibration	22

W

Warnings	9
Warranty and Field Service	45
Water Cooling Option Specifications	33
Water Requirements	33